



ATTRACTING BIRDS

in Ohio

TABLE OF CONTENTS

Attracting Birds	1
Food	2
Feeder Types	2
<i>Peanut Butter or Suet-filled Log</i>	2
<i>Metal Guard</i>	2
<i>Single-sided Hopper Feeder</i>	3
<i>Suet Box</i>	3
<i>Tray Feeder</i>	4
<i>Double-sided Hopper Feeding Station</i>	4
Food Types	5
Feeder Cleanliness	6
When to Feed	6
Predators at Your Feeding Station	7
Squirrels and Raccoons	7
Habitat	8
Natural Food	8
Shelter	9
<i>Birdhouse Dimensions and Placement</i>	10
<i>Purple Martin House</i>	11
<i>Tree Swallow House Plans</i>	12
<i>Bluebird House Plans</i>	12
<i>Small Forest Bird House</i>	13
<i>Roosting Shelter</i>	13
<i>Mourning Dove Nest Structure</i>	14
<i>Nest Shelf for Robins and Phoebes</i>	14
<i>Unroofed Shelf for use Under Protective Hanging</i>	14
<i>Wood Duck Nest Box</i>	15
<i>Wren Houses</i>	16
<i>American Kestrel or Screech Owl Nesting Box</i>	16
Predator Guards	17
General Care and Maintenance	19
Water	20
In Summary	21

ATTRACTING BIRDS

Birds are everywhere around us. We see them in our backyards, as we drive along our streets and highways, and even where we work and play. Birds captivate us for many reasons – probably the most obvious is because of their beautiful songs. The flute-like melody of the wood thrush is soothing; the robin singing in February gives us hope of spring. Second to their varied calls are their bright colors—consider the brilliance of the scarlet tanager or the “electric yellow” goldfinch. The drab camouflage of other species is equally intriguing like the near invisible nighthawk roosting on a tree branch. Further, the speed of some (swallows and swifts) and grace (a heron silently wading) of others; or the power and maneuverability of a Cooper’s hawk chasing a sparrow through the backyard are more reasons to be in awe of these feathered creatures. Even their differences in size can be captivating from the tiny hummingbird to the enormous trumpeter swan. If their size, colors, and songs aren’t enough then there are also their behaviors – the instincts of a killdeer feigning a broken wing to protect its nest, mate feeding of cardinals or nest parasitism of cowbirds are all activities that are interesting. With all the fascination surrounding birds, it is no wonder that people strive to attract birds into their backyards to have them closer to watch and listen to.

Birds can be enticed to share our space in many ways. Like any wildlife species, their needs are basic: food, water, and shelter. By providing these needs we can effectively bring birds into our lives so we can enjoy them more. If you want more birds in your life, read on...

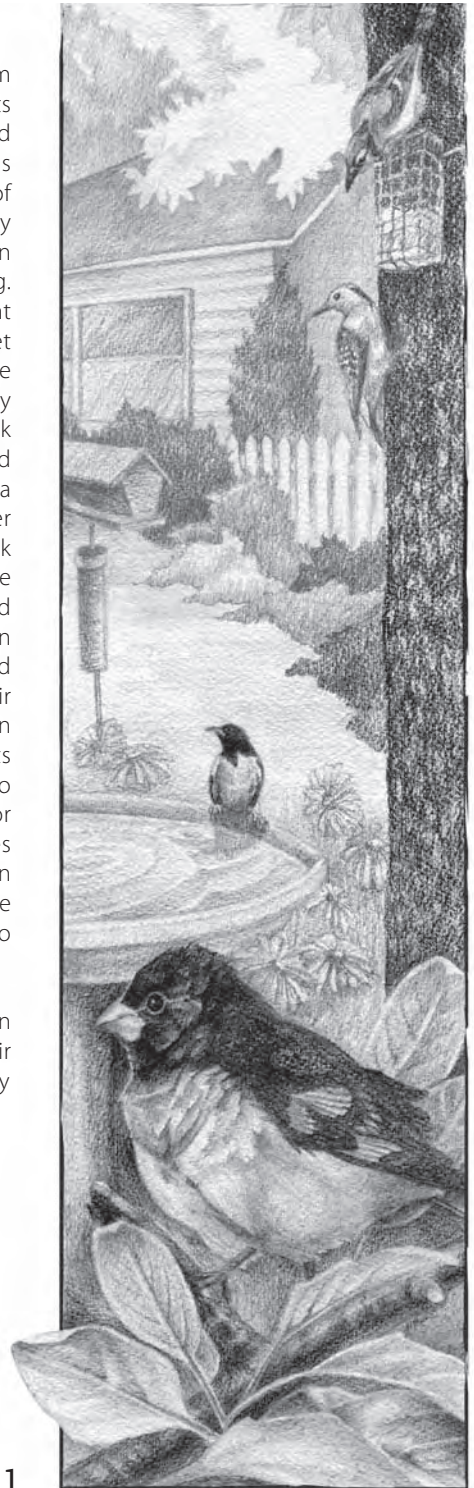

FOOD

Bird feeding is one of the most popular backyard hobbies, enjoyed by millions of people. The effort is quite simple and most always successful—a bird feeder filled with seed placed in just about any environment—city or country—will result in at least one or more types of birds taking advantage of the food source. However, just like any other hobby you can put as much into it as you want.

FEEDER TYPES

There are many, many different types of feeders available. Some are for general seed like a hopper feeder intended for a mixed blend; other feeders are intended for specific seeds, such as a thistle feeder. Some feeders hang, others mount on posts, while still others sit on the ground. A good rule of thumb is to have a variety of feeders to appeal to the largest variety of birds because, like the different feeder types, different species of birds also have their preferred means of obtaining food. For example, some types of birds like chickadees, nuthatches, and titmice are more likely to light on an elevated feeder to get to the seed inside. Other birds, such as juncos and mourning doves, favor feeding on the ground. Of course then there are the generalists like cardinals and blackbirds that will feed either way. By providing an assortment of feeders you can accommodate a diversity of birds.

PEANUT BUTTER OR SUET-FILLED LOG

Cut a 15-18" length of a 3-4" diameter branch. Drill holes partway into the log and spread peanut butter or softened suet into the holes. (See illustration on page 3).

METAL GUARD

Metal guards on trees keep cats, raccoons, and squirrels away from bird nests and feeding stations.

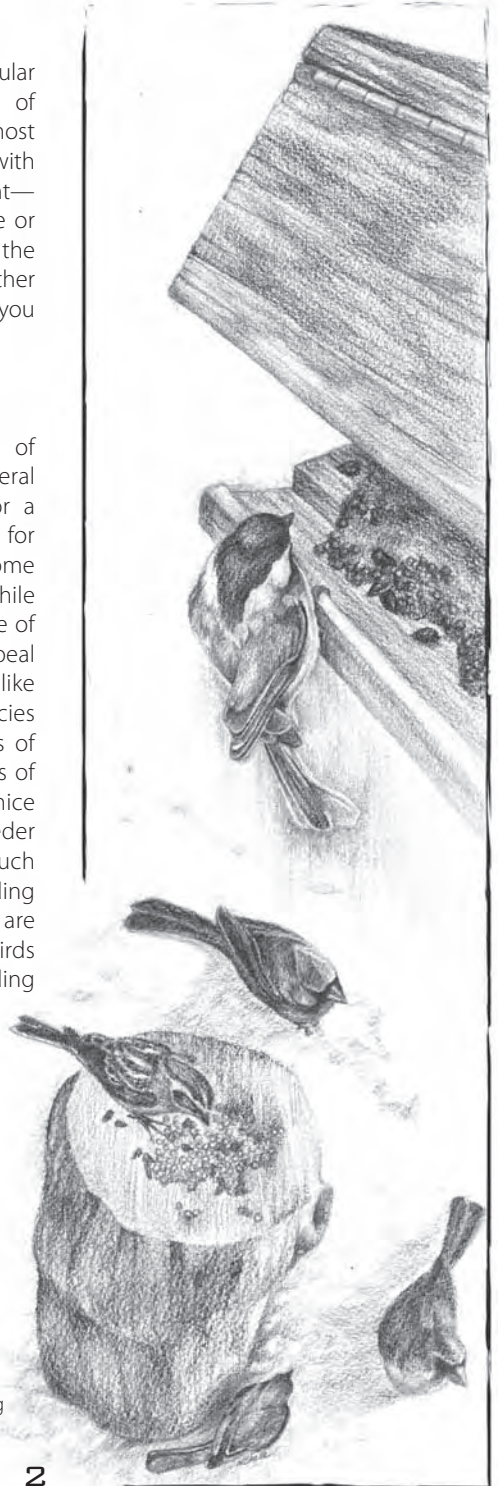

SINGLE-SIDED HOPPER FEEDER

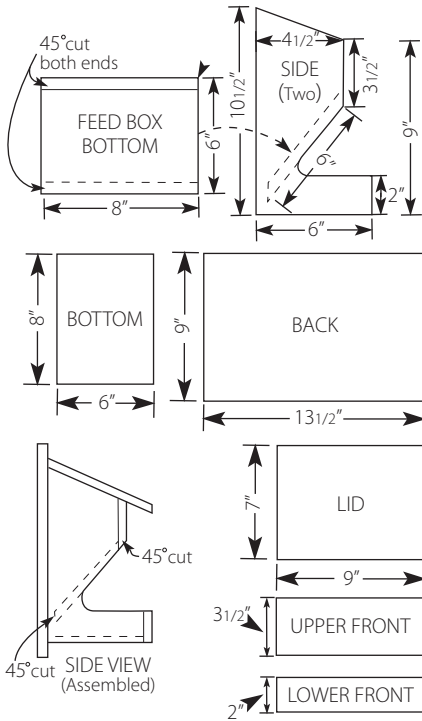

Hopper feeders offer the advantage of holding several days' supply of food, mainly grains. Suet feeders bring the insect eaters in close. Suet is an important winter food for many birds.

SUET BOX

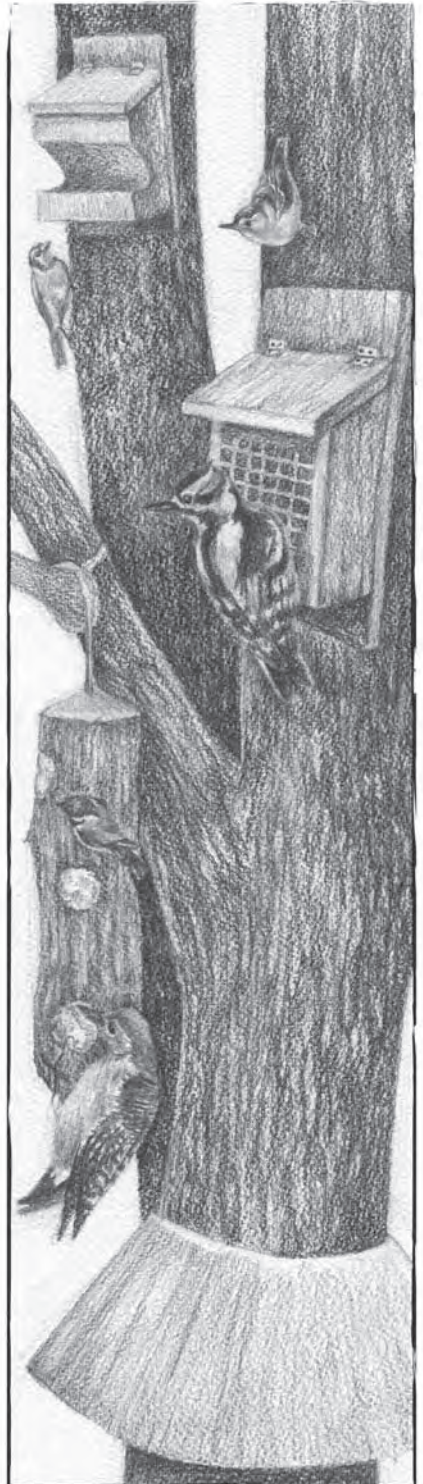
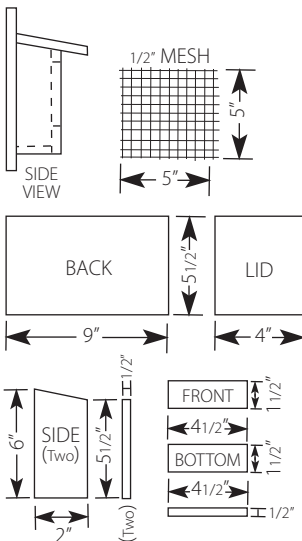

TRAY FEEDER

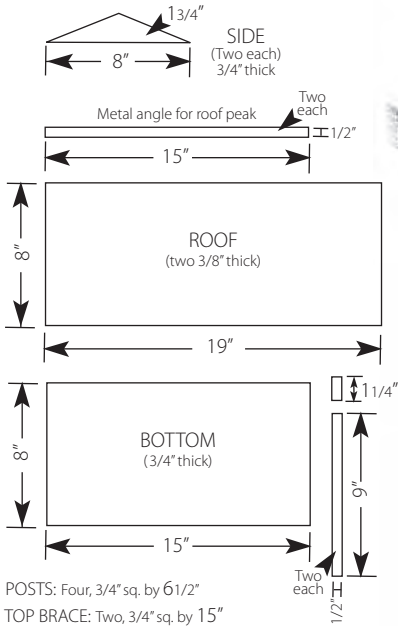

POSTS: Four, 3/4" sq. by 6 1/2"
 TOP BRACE: Two, 3/4" sq. by 15"

DOUBLE-SIDED HOPPER FEEDING STATION

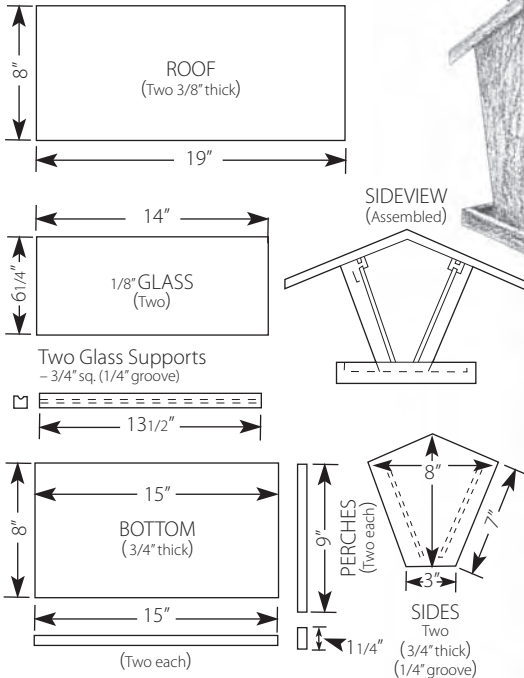

FOOD TYPES

In addition to feeding preferences, different species of birds also have food preferences. Black oil sunflower is a high energy food and the favorite seed of most birds found in Ohio. A mix of sunflower and white proso millet is a good general mix for many birds. Other seeds such as sorghum (also called milo), wheat, and cracked corn are commonly used in the less expensive seed mixes as filler. While these foods may be eaten by popular game birds such as quail, pheasant and wild turkey they aren't the favorite of most songbirds and in some cases can even attract undesired bird species like the house sparrow. Nyjer seed, or thistle as it is more commonly known, is a small seed and a favorite of goldfinches and house finches.

Other foods can also be offered as a supplement to attract specific types of birds. Peanuts and other nuts will be relished by blue jays and woodpeckers. Chopped apples, raisins, currants, and other fruit will appeal to mockingbirds, some woodpeckers, catbirds, and robins. Mealworms will be gobbled up by bluebirds, wrens, and chickadees. Suet and peanut butter will tempt nuthatches, woodpeckers, and other birds that feed on insects and grubs. There are even specialty feeders to accommodate these specialty foods.

To attract hummingbirds, prepare a nectar solution of 4 parts water to 1 part white, granulated sugar. Boil the mixture for 2 minutes then allow it to cool. A minimal amount of red food coloring may be added to the sugar water mixture, but it is not necessary. Hummingbird feeders require considerable maintenance – the feeder should be thoroughly cleaned (including scrubbing the feeding ports with a cotton swab or pipe cleaner) and fresh solution supplied at least twice a week. A poorly maintained hummingbird feeder will quickly become moldy which can harm the birds.



Myth: Hummingbird feeders should be taken down by Labor Day so these birds will know to migrate.

Truth: Hummingbirds know when to migrate regardless of whether feeders are available or not. Keep your hummingbird feeder up into the fall as long as you can maintain it. In addition to benefiting migrating ruby-throated hummingbirds, you may be lucky to host a rare rufous hummingbird, a Western species that occasionally visits the Midwest.

FEEDER CLEANLINESS

Whatever feeder or type of food you provide it is a good idea to keep your feeders spaced out from one another. A bird feeding station will likely attract larger numbers of birds into an area than would naturally occur, so to lessen the threat of disease transmission between the birds, provide adequate distance between feeders so the birds aren't crowded. Further, thoroughly scrub feeders at least once a year with a 10:1 ratio of water to bleach for disinfecting. Allow the feeder to dry thoroughly before refilling. Also clean compacted seed and chafe out of the feeding trays on a regular basis, especially if it is damp. It is all right that some seed falls on to the ground below a feeder—this will provide for the bird species that like to feed on the ground. However, if the weather is damp for an extended time the area should be raked clean to help lessen the growth of molds.

WHEN TO FEED

Many people prefer to just feed wild birds in the winter months. But bird feeders can be kept up through all seasons of the year. In either case, keeping feeders full on a regular basis will help maintain consistency with the birds that are visiting. Feeders that remain empty for several days in a row are an unreliable source of food for the birds and so will be an unreliable source to attract birds. It is important to maintain feeders during times of winter snow, cold and ice, particularly in the early morning and late afternoon hours. It is these times that birds will feed the heaviest in order to build or replenish critical fat reserves needed to make it through weather extremes. You will do a tremendous favor to your backyard birds to clean you feeders of snow and ice with the same thoroughness as you do your sidewalk. A fully stocked feeder is of no use to the birds if they cannot get to the food inside because of a layer of snow or ice.

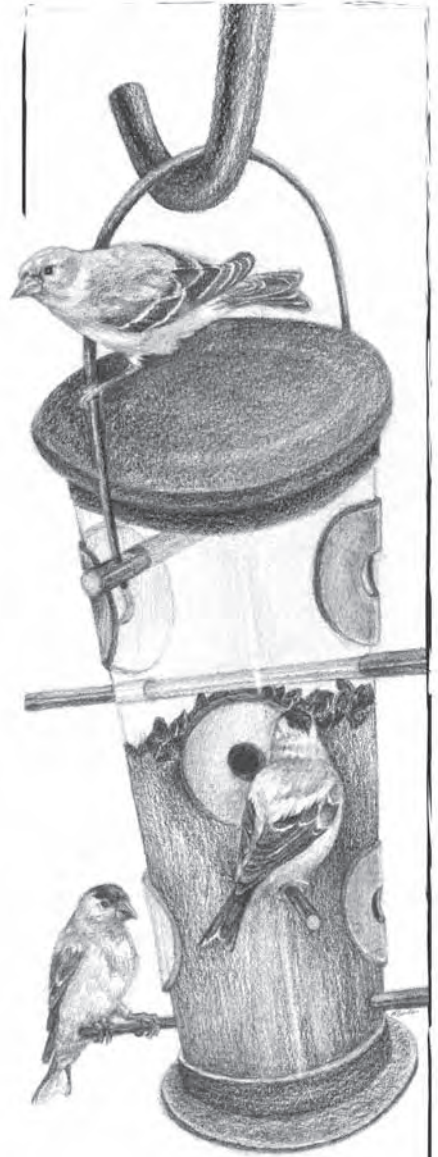

Myth: *Thistle feeders should be taken down in fall because the goldfinches leave.*

Truth: *Goldfinches do not leave Ohio in the fall—they simply molt their bright yellow feathers and appear drab green for the winter. So you can continue to feed thistle through the colder months.*

PREDATORS AT YOUR FEEDING STATION

Cooper's hawks, sharp-shinned hawks, and the American kestrel are three raptor species in Ohio that regularly feed on other birds. It is possible that one or more of these predators may utilize a bird feeding station as its hunting grounds, especially during winter, preying on the songbirds visiting the feeder. This is a natural and normal part of the food chain and should be considered similar to a robin eating worms out of the lawn or a flycatcher "hawking" for insects. If a front-row view of the predator/prey relationship is still upsetting to you, know that the hawk won't eat all of the birds – as the survivors wise up to the threat, they may avoid the feeders for a time, but will return when the hawk moves on. House cats on the prowl out-of-doors however, is a totally unnatural scenario. The negative effect of house cats on wildlife is staggering. Even the most well-fed feline will still kill birds and small mammals. It is best for your pet and wildlife if house cats are kept in the house. For more information on the American Bird Conservancy's *Cats Indoors!* campaign visit: www.abcbirds.org/cats/ on the Internet.

SQUIRRELS & RACCOONS

In addition to birds, feeders can also attract squirrels, raccoons, and other animals. There isn't much that can be done to prevent these uninvited guests from cleaning up the spilled seed on the ground, but you might want to take steps to keep them from climbing onto feeders. There are several feeders specifically designed to keep squirrels and larger mammals off. Most are weight activated, either closing off access to the seed or spinning when an animal weighing more than a typical songbird climbs on. Another option would be to use a baffle to keep climbing animals off of the feeder. There are many different baffles available commercially—or you can fabricate your own— that install over the top of hanging feeders or on a post for pole-mounted feeders. Some of the predator guards explained later in this publication to protect nest boxes can also be used to protect bird feeders.

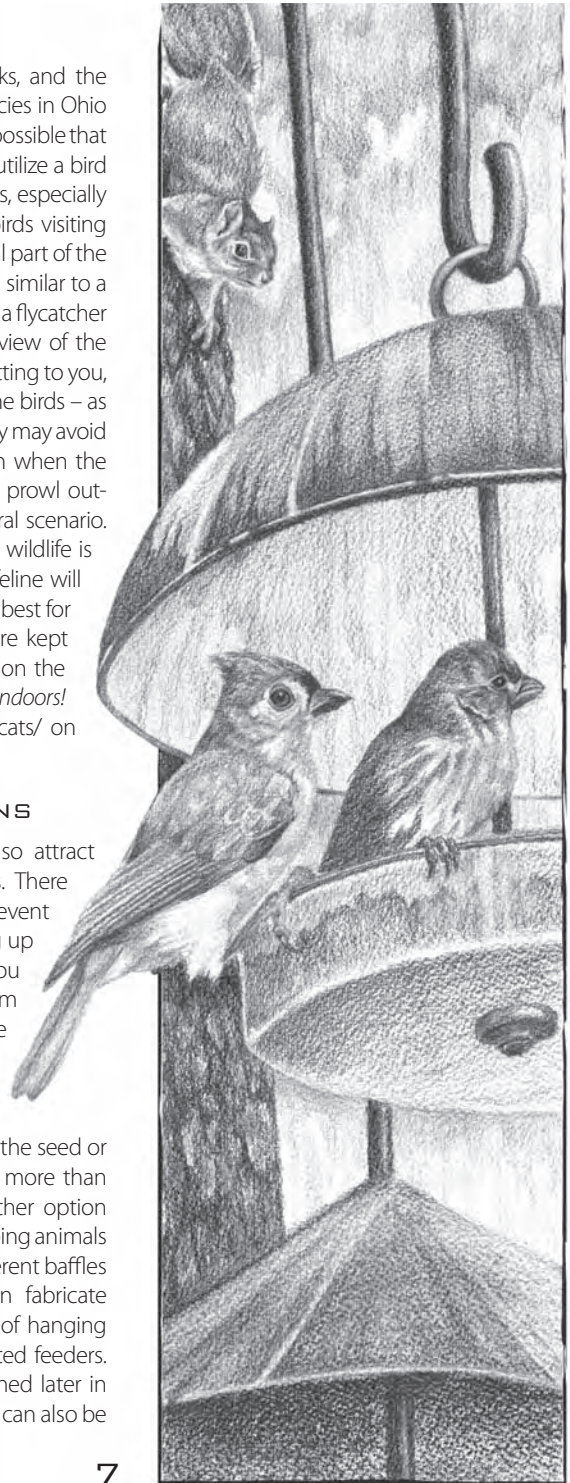

HABITAT

Bird feeders are a quick and easy way to attract birds, however the best approach is to give more consideration to their long-term habitat needs. Plantings and other features that duplicate natural habitats are a more inherent and permanent way to provide the basic needs of food and shelter throughout the seasons. Further, when you provide habitat specifically for birds, other wildlife will also benefit!

NATURAL FOOD

Gardening and landscaping for wildlife are great ways to beautify our yards and communities while still providing for wildlife. Many of the plants that we use in ordinary landscaping can and do attract wildlife. For instance, annuals like cosmos, zinnia, and sunflower provide nectar for hummingbirds, butterflies, and bees. As a bonus, ripe seeds of these plants are readily eaten by songbirds. Perennials such as purple coneflower, cardinal flower, bee balm, and butterfly milkweed again provide nectar. And, coneflower seed is a favorite of goldfinches plus the milkweed is a host plant for the monarch butterfly caterpillar. Shrubs including serviceberry, dogwood, sumac, elderberry, and chokeberry will supply food for birds. Trees (oak, ash, sweet gum, apple, crabapple, and maple) also produce nuts, fruits, and/or seeds that will be used by birds and other wildlife. Vines such as American bittersweet, scarlet trumpet creeper, and grape are equally valuable.



SHELTER

Birds need two kinds of shelter: protection from predators and harsh weather, and cover in which to nest. Trees, shrubs, and vines in our landscapes can provide both kinds of shelter. For example, a firethorn shrub with its thick, prickly branches or a dense spruce tree both will give a cardinal a place to escape a predator or snowstorm as well as a place to build a nest to raise young. By choosing wisely, the species we landscape with can also provide for wildlife. Important note: when selecting plants for your landscape avoid invasive species including bush honeysuckles, buckthorns, and perennials like purple loosestrife.

For more information on attracting wildlife, see Publication #396, *Urban Landscape Management for Wildlife*

Ohio's top 10 invasive plant species to avoid:

1. *Purple loosestrife*
2. *Glossy (or Shining) buckthorn*
3. *European (or Common) buckthorn*
4. *Japanese honeysuckle*
5. *Japanese knotweed*
6. *Autumn-olive*
7. *Common reed grass*
8. *Reed canary grass*
9. *Garlic mustard*
10. *Multiflora rose*

Even with plenty of trees and shrubs available to them, some birds just won't build a nest in such a planting, but instead need cavities in which to raise young. This includes bluebirds, wrens, chickadees, some owls, and wood ducks. They may use a hollow tree or rotted out tree limb. We can duplicate natural cavities by putting up nest boxes of certain dimensions to appeal to particular species. Still other birds like mourning doves and robins may build their nest on a base we provide. Refer to the following plans for various nest boxes and shelves.



BIRD NEST BOX DIMENSIONS & PLACEMENTS

Species	Specifications					
	Inches				Feet Above Ground	Preferred Habitat
	Entrance		Floor Dimensions	House Depth		
	Diameter	Above Floor				
Bluebird	1 ½	6-7	5 x 5	8-9	5-10	Open field
Chickadee, black capped	1 ⅞	6-8	4 x 4	8-10	5-15	Woodland
" Carolina	1 ⅞	6-8	4 x 4	8-10	6-15	Woodland
Flicker	2 ½	14-16	7 x 7	16-18	6-20	Woodland
Flycatcher, great crested	2	6-8	6 x 6	8-10	8-20	Woodland
Kestrel	3	9-12	8 x 8	12-15	10-30	Open field
Martin, purple	2 ½*	1*	6 X 6*	6*	15-20	Open fields AWAY from trees & NEAR water
Nuthatch, white-breasted	1 ¼	6-8	4 x 4	8-10	12-20	Woodland
Owl, barred	7 x 7 arch	12	12 x 12	23	20-23	Woodland
" screech-	3	9-12	8 x 8	12-15	10-30	
" barn	6 x 6	6	12 x 36	15-18	20-25	Open field
Phoebe	Open front & sides		7 x 7	8	8-12	Backyard
Robin	Open front & sides		7 x 7	8	8-12	Backyard
Swallow, tree	1 ½	5	5 x 5	6	6-10	Open field near water
Titmouse, tufted	1 ¼	6-8	4 x 4	8-10	6-15	Woodland edge & interior
Warbler, prothonotary	1 ½	6	5 x 5	8	5-10	Over and near water
Woodpecker, downy	1 ¼	6-8	4 x 4	8-10	6-20	Woodland interior (fill nestbox completely with pine shavings)
" hairy	1 ½	9-12	6 x 6	12-15	12-20	
" red-bellied	2 ½	10-12	6 x 6	12-14	12-20	
" red-headed	2	9-12	6 x 6	12-15	12-20	
Wren, Carolina	1 ½	4-6	4 x 4	6-8	5-10	Near brushy areas & backyards
" house	1 ¼	4-6	4 x 4	6-8	5-10	

*These are the dimensions for one compartment. Martins nest in colonies; therefore, martin houses should have a minimum of six self-contained apartments.

Removing unwanted species such as starlings and house sparrows will increase your chances for nesting success.

PURPLE MARTIN HOUSE

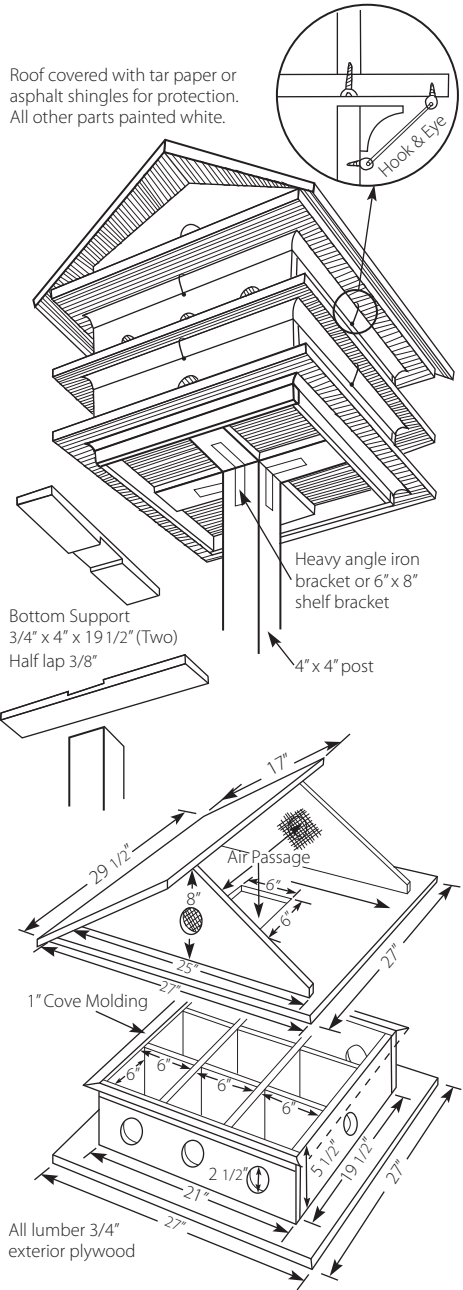

**TREE SWALLOW OR
EASTERN BLUEBIRD NEST BOX**

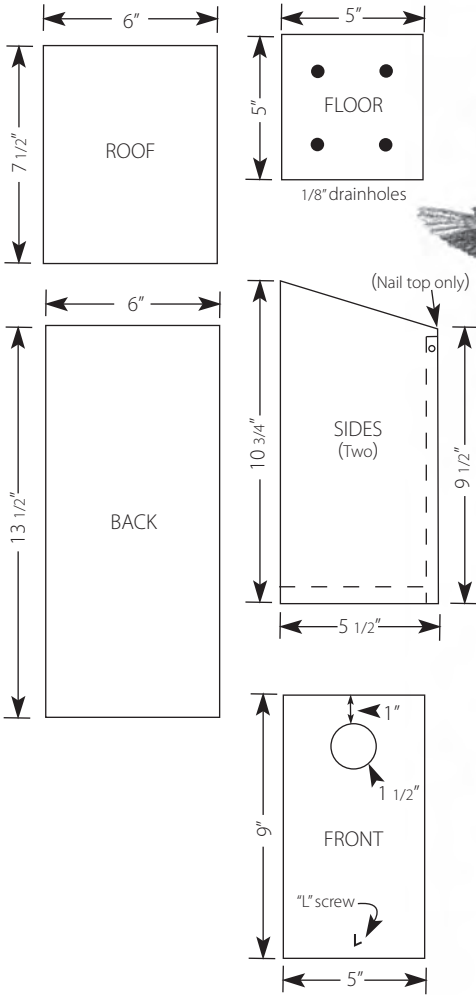

Secured with long nails from sides and an "L" screw at the bottom front. This enables front to swing out for easy cleaning.

Tree swallow boxes should be mounted near water.



SMALL FOREST NEST BOX

CHICKADEE, TUFTED TITMOUSE, NUTHATCH,
OR DOWNY WOODPECKER*

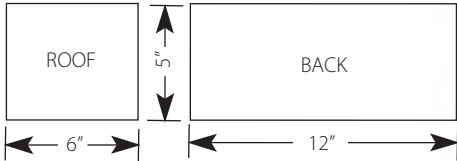
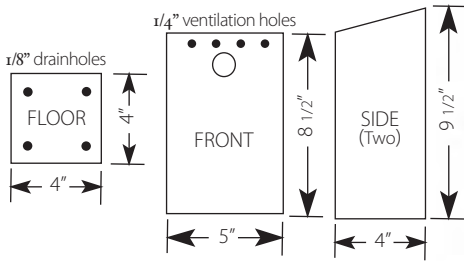

(See Table for entrance dimensions)

Screws are used to secure bottom so that it may be removed for cleaning.

*To attract woodpeckers, fill box completely with pine shavings.

ROOSTING SHELTER (FOR WINTERING BIRDS)

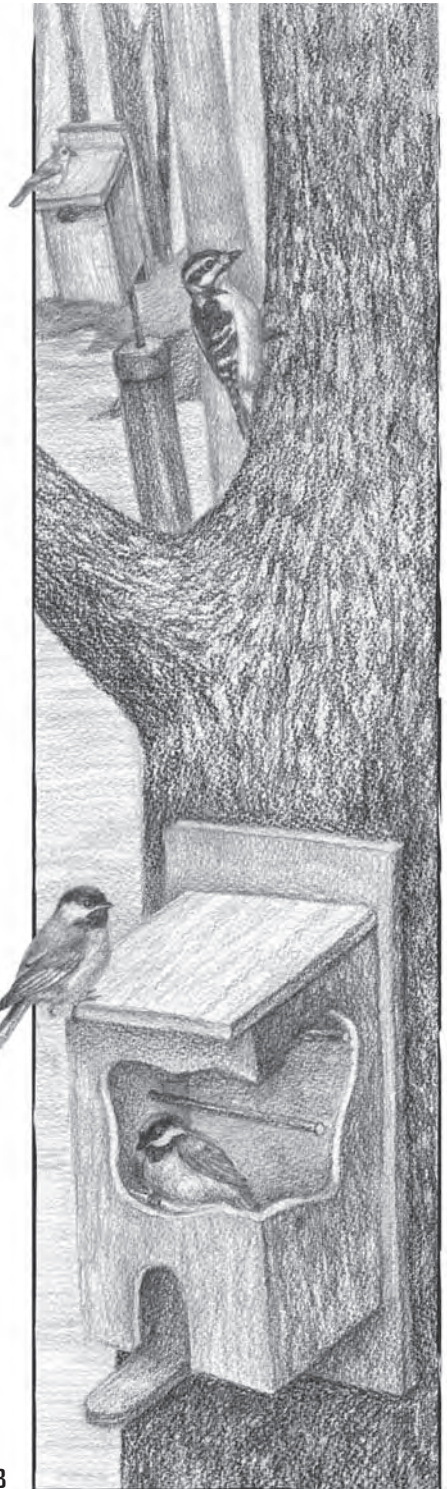
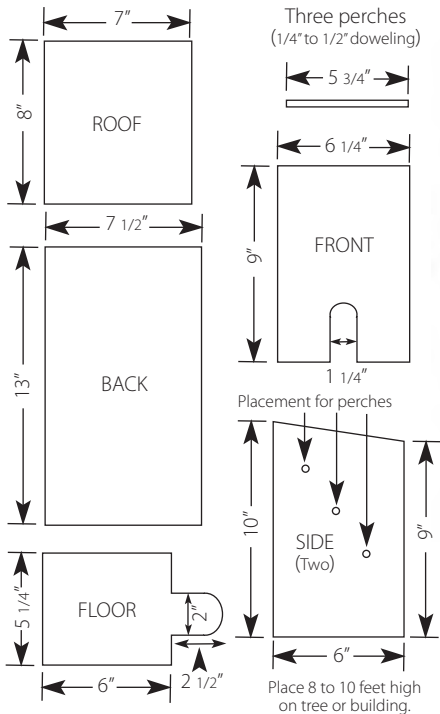

MOURNING DOVE NEST STRUCTURE

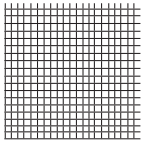

1. Cut a 12" square piece of hardware cloth.

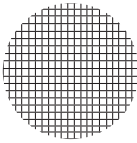

2. Trim the 12" square to form a circle.



3. Cut out a "pie" shape as shown.

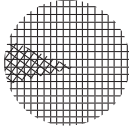

4. Close pie cut by overlapping cut edges about 3".

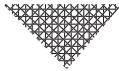

5. Side view of cone nest ready for nailing in tree.

NEST SHELF FOR ROBINS & PHOEBES

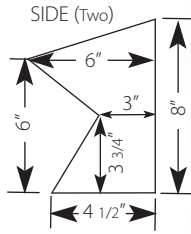
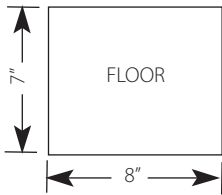
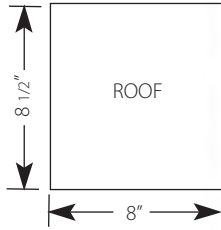
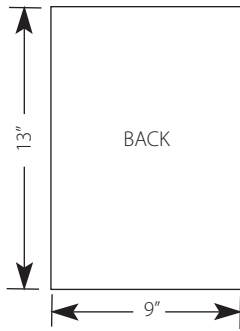

UNROOFED SHELF FOR USE UNDER PROTECTIVE HANGING (FOR ROBINS & PHOEBES)

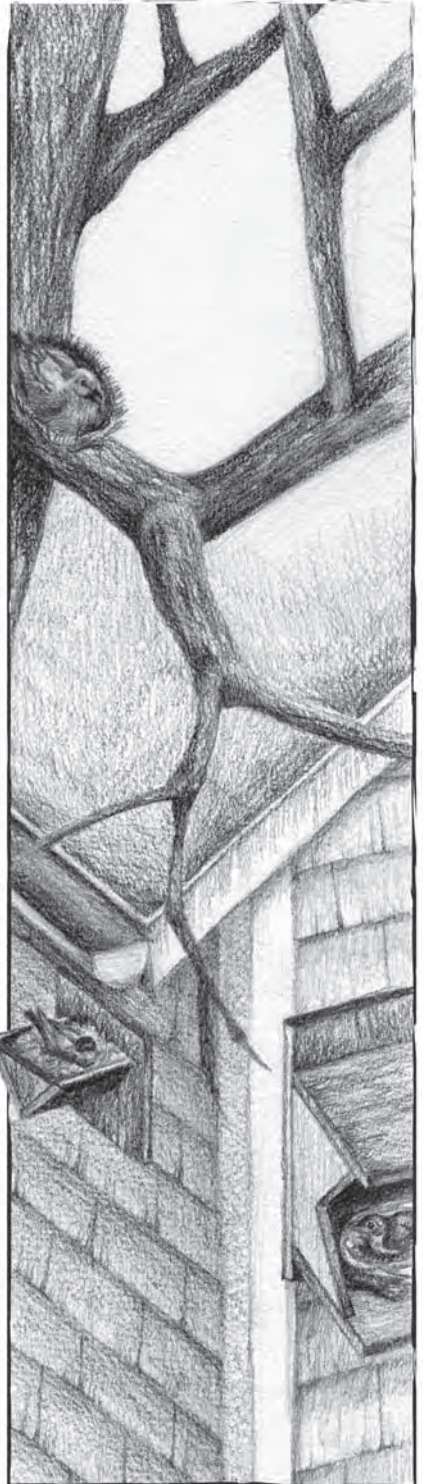
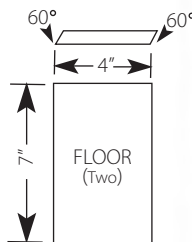
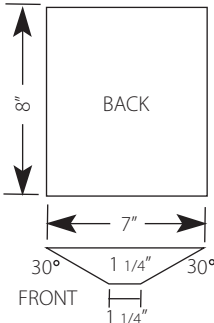

WOOD DUCK NEST BOX

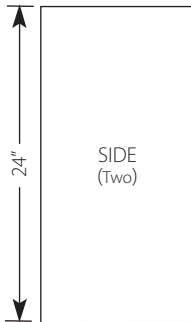
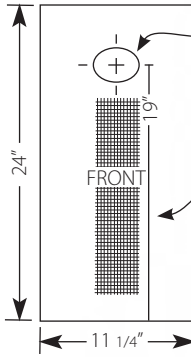
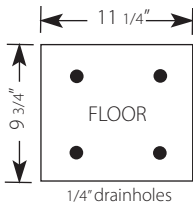
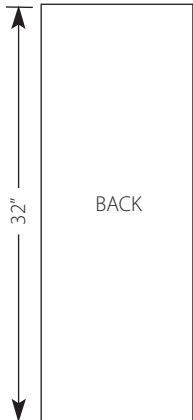
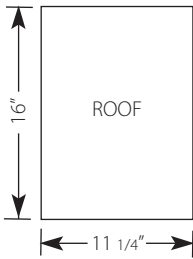

Roof secured at back with two 2" hinges. "Lock" roof by using "eye" screw and wire on side towards front. Roof can be opened for cleaning.

Mount on two 7-foot channel posts (bolted together with one-foot overlap). Bottom of box 5 feet above waterline. Post 3 feet into ground of pond or lake bottom. Metal cone secured to post prevents invasion of nest box by raccoons.

Place several inches of wood shavings in bottom of box.

LUMBER:
One 1" x 12" x 120"

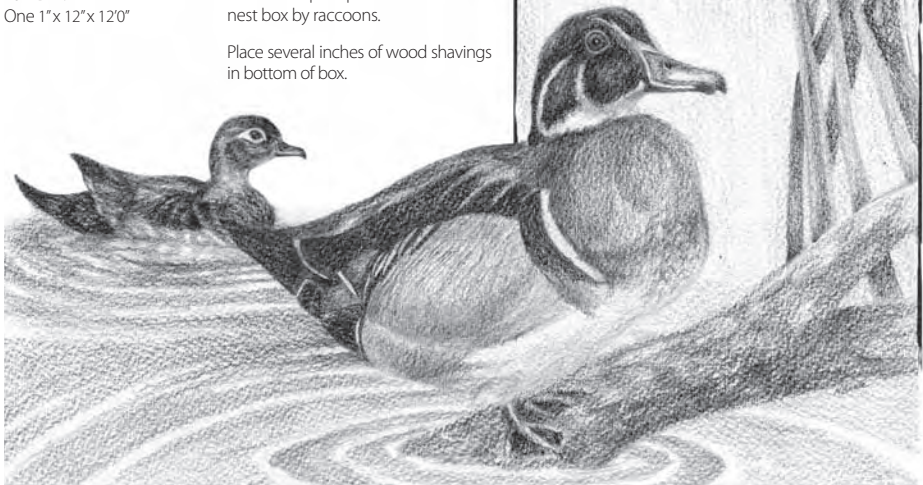
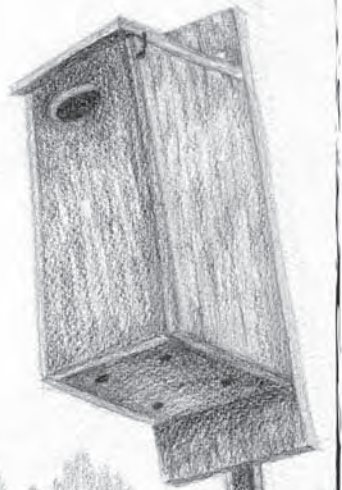

WREN HOUSES

Back same as front, except there is no entrance.

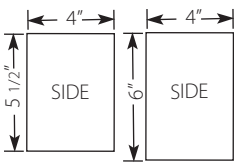
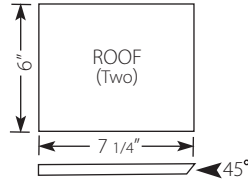
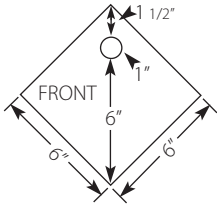

Hinged roof for observation and cleaning.

Back same as front, except there is no entrance.

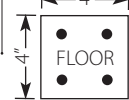
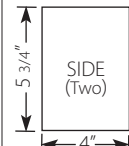
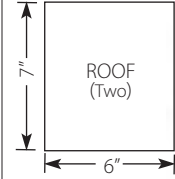
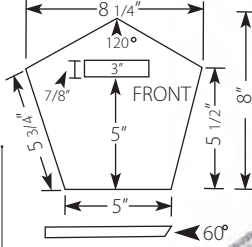

NOTE:
Constructed so sides swing out for cleaning. Both sides are secured with an "L" screw.

1/8" drainage holes

AMERICAN KESTREL OR SCREECH OWL NEST BOX

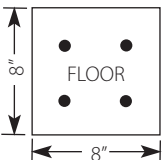
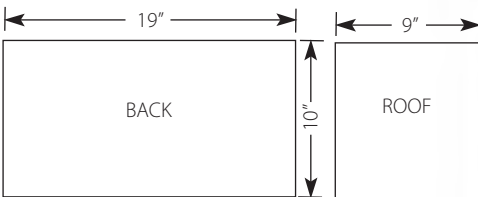
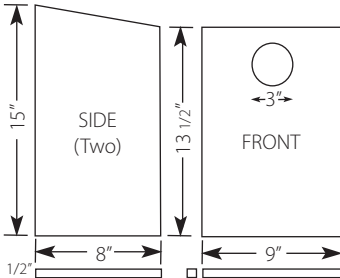

NOTE: Roof is secured by two 2" hinges, and one hook and eye fastener.

Mount in a wooded location for owls or an open, grassy area for kestrels.

Place several inches of wood shavings in the bottom of box.

1/4" drainage holes



If you put up a nest box for birds it is very important, as a landlord, that you make the nesting structure as safe as possible for the inhabitants. The responsibility includes placing the nest box in the proper habitat for the desired species and protecting it from predators. Raccoons are very numerous in all areas of Ohio and will readily investigate a nest box and make a meal of eggs or nestlings. To safeguard against predation by raccoons, snakes, and house cats, always install nest boxes on a post with a predator guard. NEVER simply nail a nest box to a fencepost or tree. For mounting a nest box, either a wood or metal post can be used. A popular choice is one-inch diameter conduit pipe that can be purchased at a hardware store and cut with a hacksaw. An eight-foot section driven two feet into the ground will keep the nest box low enough for easy maintenance, but too high for cats to jump up on to.

PREDATOR GUARDS

Any number of predator guards are available commercially or you can make your own out of common materials found at a hardware store. Whether using PVC pipe or aluminum downspout, predator guards should be at least 30 inches long and placed on the post directly below the nest box. The nature of the materials (PVC and aluminum) is slippery and when mounted properly will wobble and thus retard a raccoon or other predator from gaining a foothold and climbing up to the nest box. A cone type guard should also prevent a predator from scaling a post. The same type of predator guards used to protect nest boxes can also be used to keep raccoons off of post-mounted bird feeders.

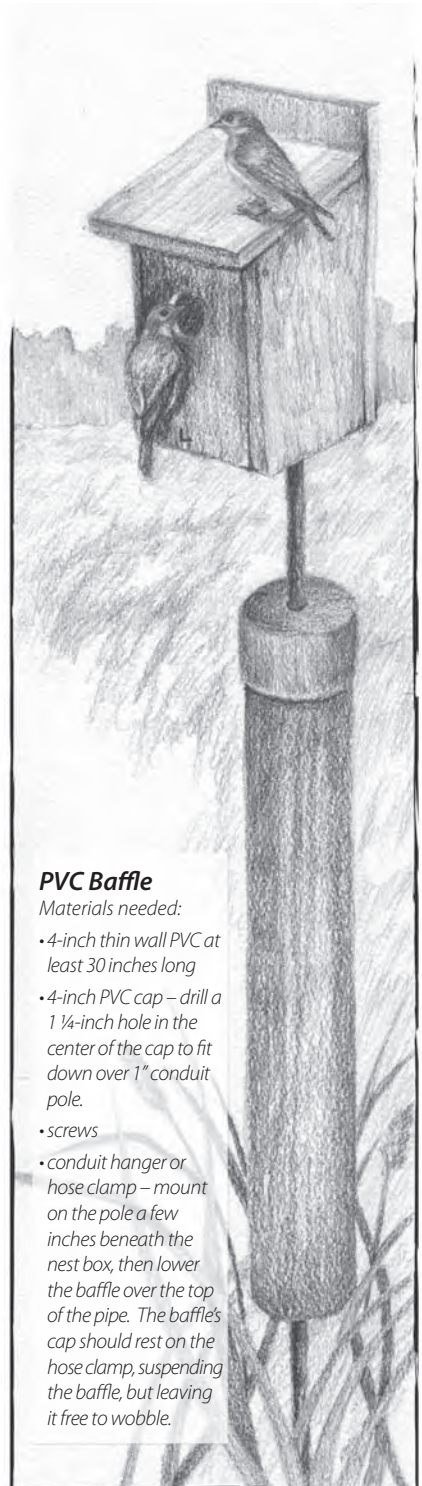

PVC Baffle

Materials needed:

- 4-inch thin wall PVC at least 30 inches long
- 4-inch PVC cap – drill a 1 1/4-inch hole in the center of the cap to fit down over 1" conduit pole.
- screws
- conduit hanger or hose clamp – mount on the pole a few inches beneath the nest box, then lower the baffle over the top of the pipe. The baffle's cap should rest on the hose clamp, suspending the baffle, but leaving it free to wobble.

Aluminum Downspout Baffle

Cut a 10-foot downspout into thirds with a hacksaw to make three guards. Attach the downspout to the post or the back of the nest box using screws or wire.

Note: As described, this downspout is not snake-proof. To add extra protection against snakes, pack wads of steel wool into the top three inches of the guard, directly below the nest box.

Cone Guard

Materials needed:

- 3-foot diameter circle of 24- or 26-gauge galvanized sheet metal
- ¼ inch round head stove bolts
- 2 hanger iron straps

[refer to drawing]

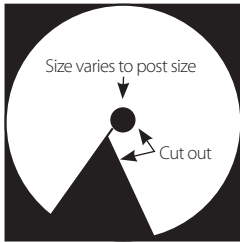

3' x 3' Galvanized sheet metal

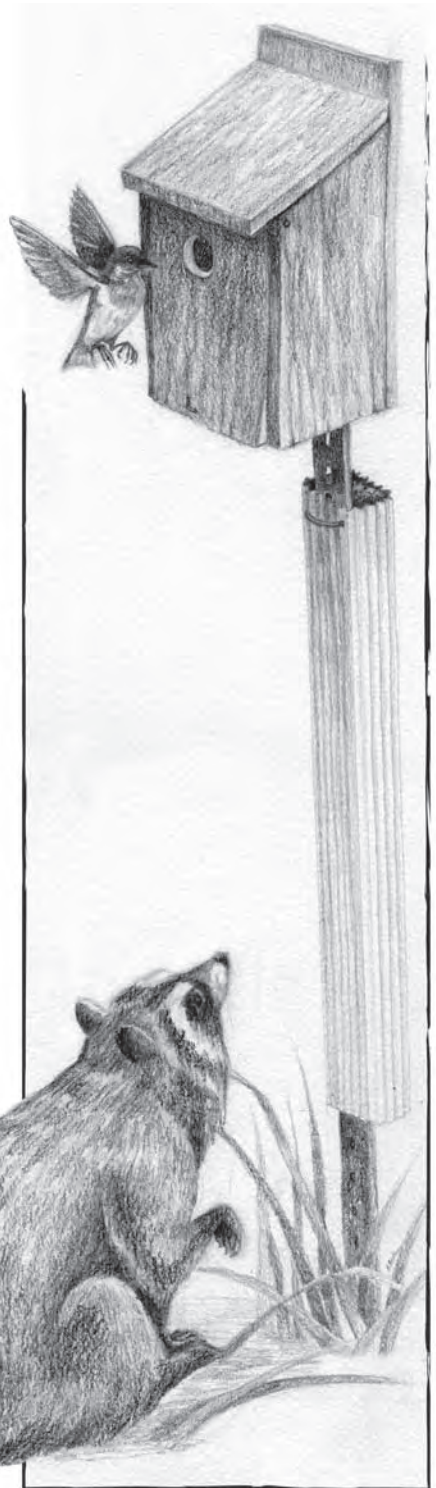
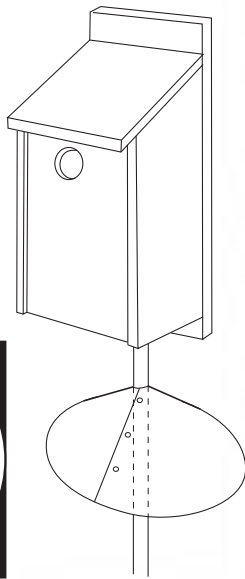

GENERAL CARE & MAINTENANCE

Bird houses and nesting boxes should be cleaned at least once each year. This type of maintenance will help keep the nest box useful longer and reduce bird parasite problems. Cleaning should be done prior to March, but is better done in the fall to make the box clean and available for winter roost use. The Bird Nest Box Dimensions and Placements Table gives measurements for bird nest box construction and location. Other tips include: Erect two bluebird houses 25 feet apart in an open, mowed grassy area to increase the odds of attracting both bluebirds and tree swallows. Place several inches of wood chips in houses for owls and wood ducks. Experiment with constructing rustic houses out of sections of tree limbs with natural holes. Gourds may be used for great-crested flycatchers, wrens, tree swallows, and purple martins. Phoebe nesting platforms should be mounted under eaves and near water. Robin platforms should have a roof while tree swallow nest boxes should be placed near water.

Purple martins can be a challenge to attract. Housing or gourds for martins should be located in open areas, near water and be available by mid-April when the juvenile males return to the area. Vital to attracting and keeping purple martins is control of competing species, namely house sparrows and European starlings. For detailed information on how to attract martins, contact the Purple Martin Conservation Association at www.purplemartin.org.



WATER

In Ohio we are fortunate to have adequate rainfall so in general, there is often plenty of water for wildlife. The exceptions occur when there is a summer drought or a winter freeze. During harsh conditions such as these, a bird bath could attract more birds to your yard than a bird feeder! Most birds prefer a shallow bath of 1 1/2 to 2 inches of water. If your bird bath is deeper than this, add flat rocks in the bottom to bring it to the proper depth. In the summer, bird baths should be scrubbed out weekly to keep algae at a minimum, as well as to guard against becoming a breeding pool for mosquitoes. Moving water is even more attractive to birds than still water, so consider a mister or dripper (available commercially or you can make your own) to add more appeal. In the winter an electric bird bath heater will keep the water open and available to the birds.

Easy Milk Jug Dripper

Materials needed:

- Plastic milk jug with screw-on cap
- Sewing needle
- Rope
- Clay pot that will cover the milk jug (optional)

Directions:

1. Wash the empty milk jug well.
2. Using the needle, poke 1 hole in the bottom of the jug
3. Fill the jug with water and replace the cap.
4. Adjust the flow of water by tightening or loosening the cap. A slow drip of water (8-10 drips/minute) is best.
5. Tie the rope to the handle of the jug. If you want the jug to be covered, slip the clay pot (up side down) over the top of the jug. Thread the rope through the hole in the bottom of the pot.
6. Hang the dripping jug from a tree or hook over a birdbath so that the water drips into the birdbath.



IN SUMMARY

Attracting birds to your backyard, office lot, or community park can truly add quality to life and provide endless entertainment and an opportunity to discover more for children and adults alike. Depending on an individual's level of interest the antics of birds at feeders or when nesting can be simple amusement without knowing one species from another, or it can lead to a lifetime of learning as much as possible about birds, including being able to identify species by sight and song. As more and more is learned about bird species – their habits, habitats and relationship to the environment become increasingly interesting which can make one more knowledgeable about wildlife conservation as a whole.

For a list of birds that occur in Ohio,
request Publication #363, *Birds of Ohio*.





Ohio Department of Natural Resources

DIVISION OF WILDLIFE

Ted Strickland, Governor • Seah D. Logan, Director • David M. Graham, Chief

PUBLICATION 37 (R40S)

